



APPROVED BY:
Name: Date:
Name: Date:
Name: Date:

UNLESS A PROFESSIONAL SEAL WITH SIGNATURE AND DATE IS AFFIXED, THIS DOCUMENT IS PRELIMINARY AND IS NOT INTENDED FOR CONSTRUCTION.

REVISIONS

No.	Description	Date

Rel. Date: 1-13-23

FLOORPLAN OPTION D

A101-D

GENERAL BUILDING INFORMATION
BUILDING FOOTPRINT = 34,308 SQFT
BUILDING OVERALL = 102,008 SQFT
CONSTRUCTION TYPE = IB
BUILDING HEIGHT = 29'-6" (TOP OF ROOF)
BUILDING CLASSIFICATION = S1
BUILDING IS FULLY SPRINKLED

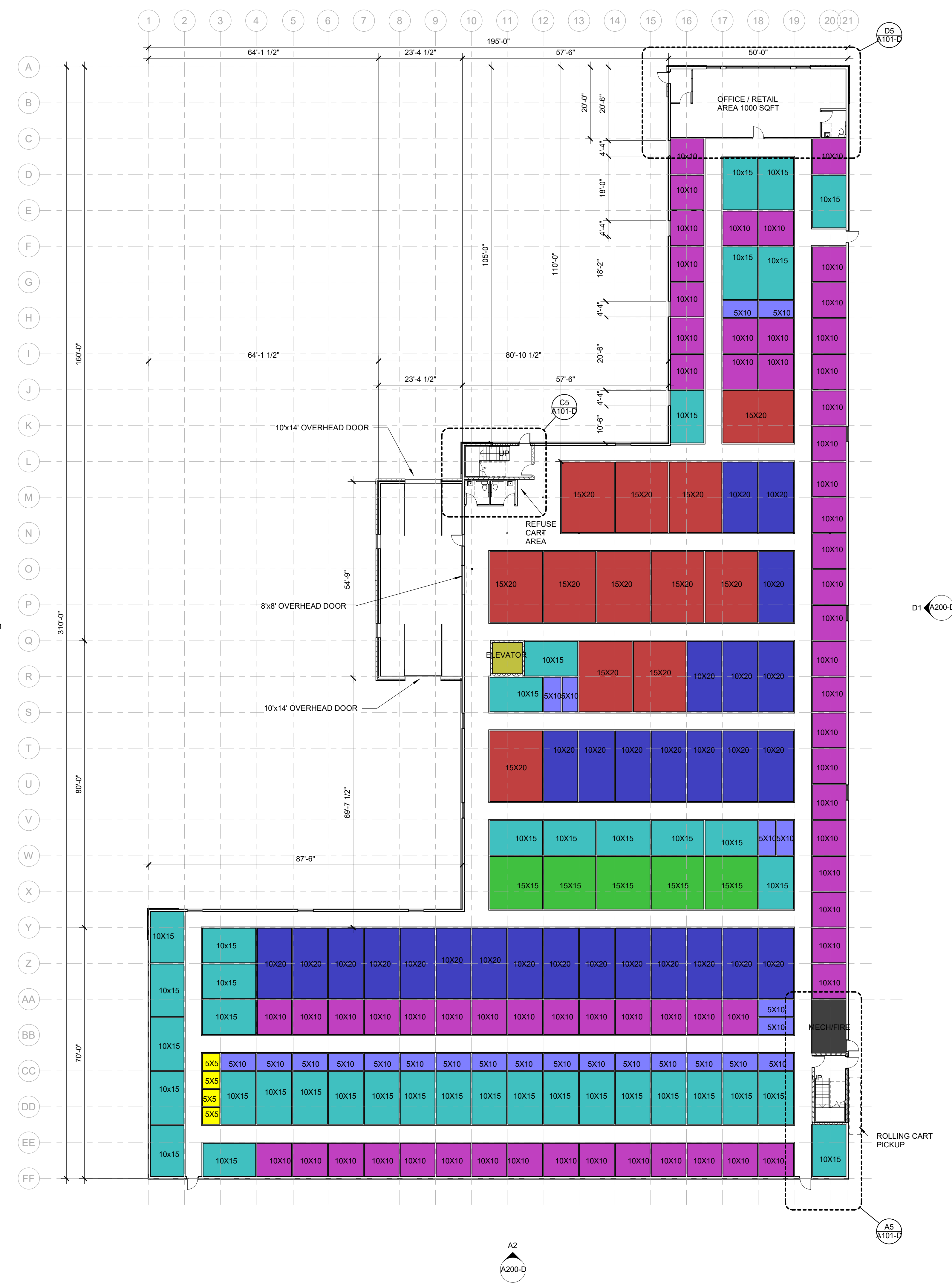

Department Legend

Color	Size	TOTAL MAIN LEVEL
Yellow	5X5	4
Blue	5x10	24
Purple	10X10	64
Teal	10X15	40
Dark Blue	10X20	28
Green	15X15	5
Red	15X20	12
Grey	MECHANICAL	
Olive	CIRCULATION	

OFFICE PLAN D5
1/8" = 1'-0"

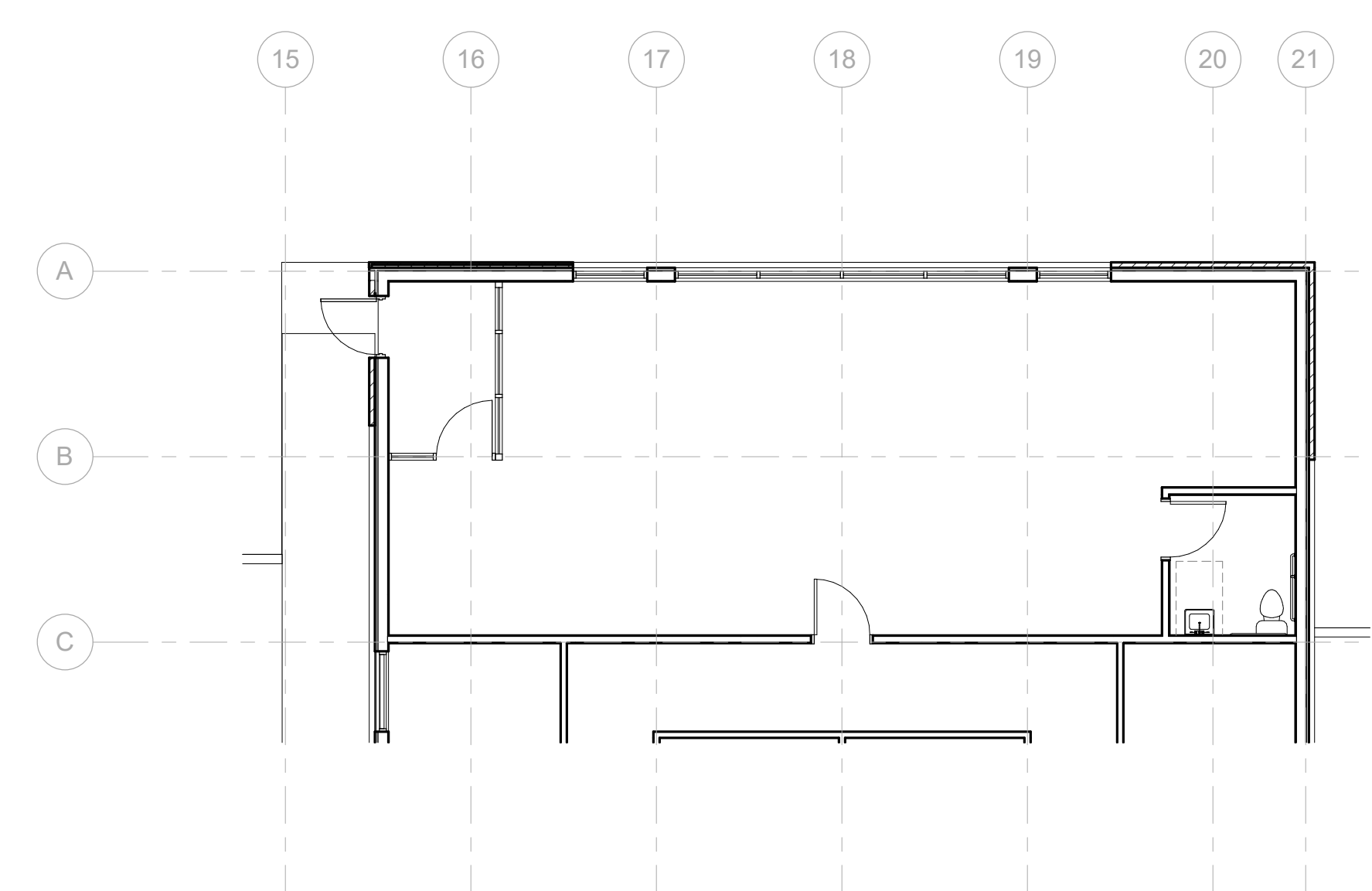

NORTH STAIRS / RESTROOM C5
1/8" = 1'-0"

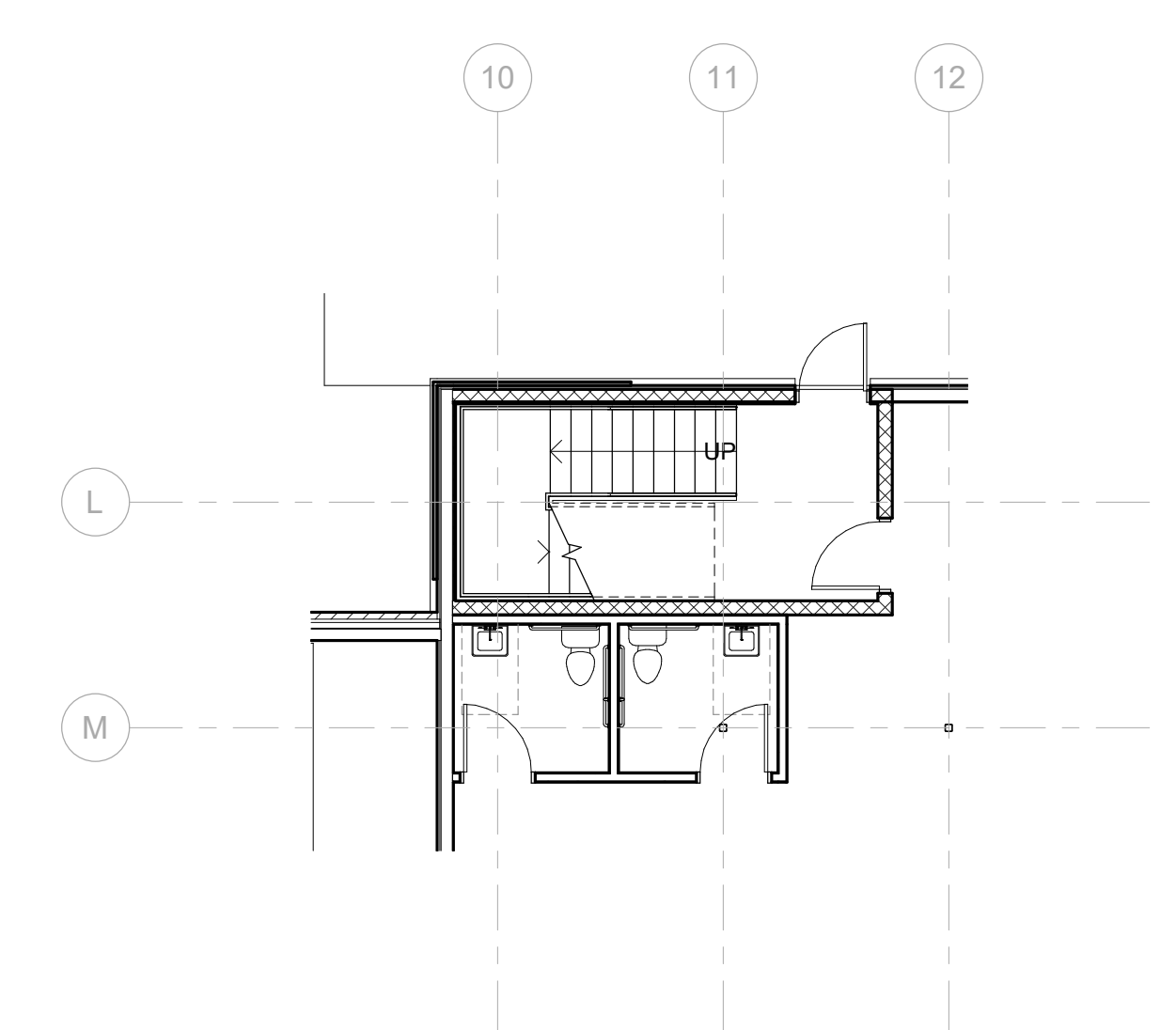

SOUTH STAIRS A5
1/8" = 1'-0"

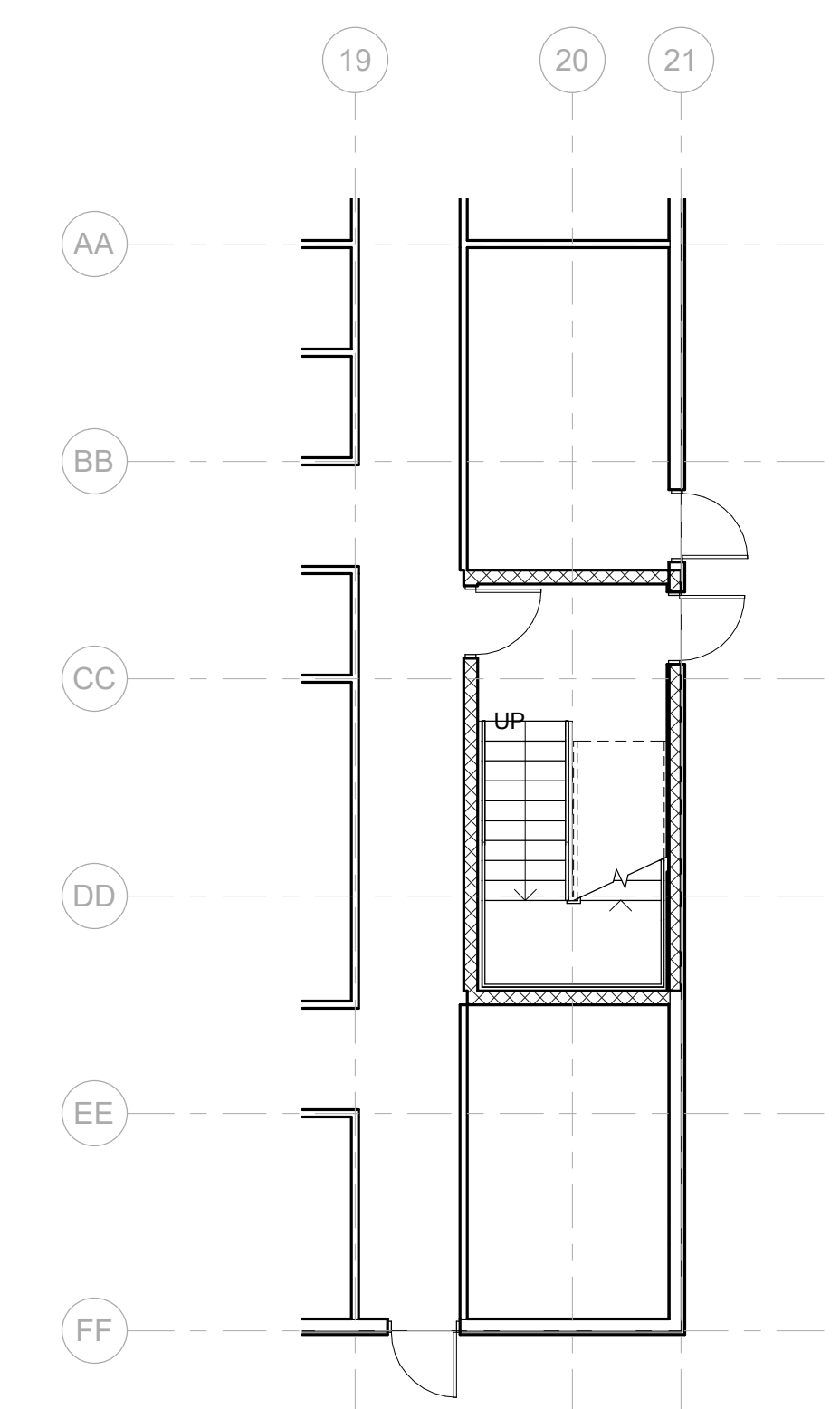

FLOORPLAN - MAIN LEVEL A1
1/16" = 1'-0"

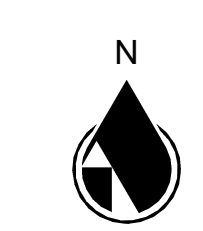

0 8' 16' 32'



ADAMS ARCHITECTS
700 Massachusetts St.
Suite 307
Lawrence, Kansas 66044
(785) 218-3880
www.adamsarchts.com

APPROVED BY:

Name: --- Date: ---
Name: --- Date: ---
Name: --- Date: ---

UNLESS A PROFESSIONAL SEAL WITH SIGNATURE AND DATE IS AFFIXED, THIS DOCUMENT IS PRELIMINARY AND IS NOT INTENDED FOR CONSTRUCTION.

REVISIONS

No.	Description	Date

Rel. Date: 1-13-23

FLOORPLAN OPTION D

A102-D

Department Legend

Color	Size	PER FLOOR	TOTAL 2 - 3
Yellow	5X5	29	58
Blue	5x10	71	142
Purple	10X10	122	244
Teal	10X15	43	86
Dark Blue	10X20	7	14
Green	15X15	1	2
Red	15X20	1	2
Grey	MECHANICAL		
Olive	CIRCULATION		

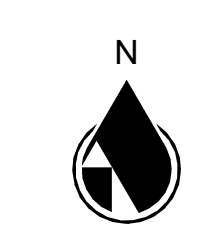
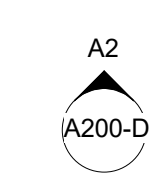
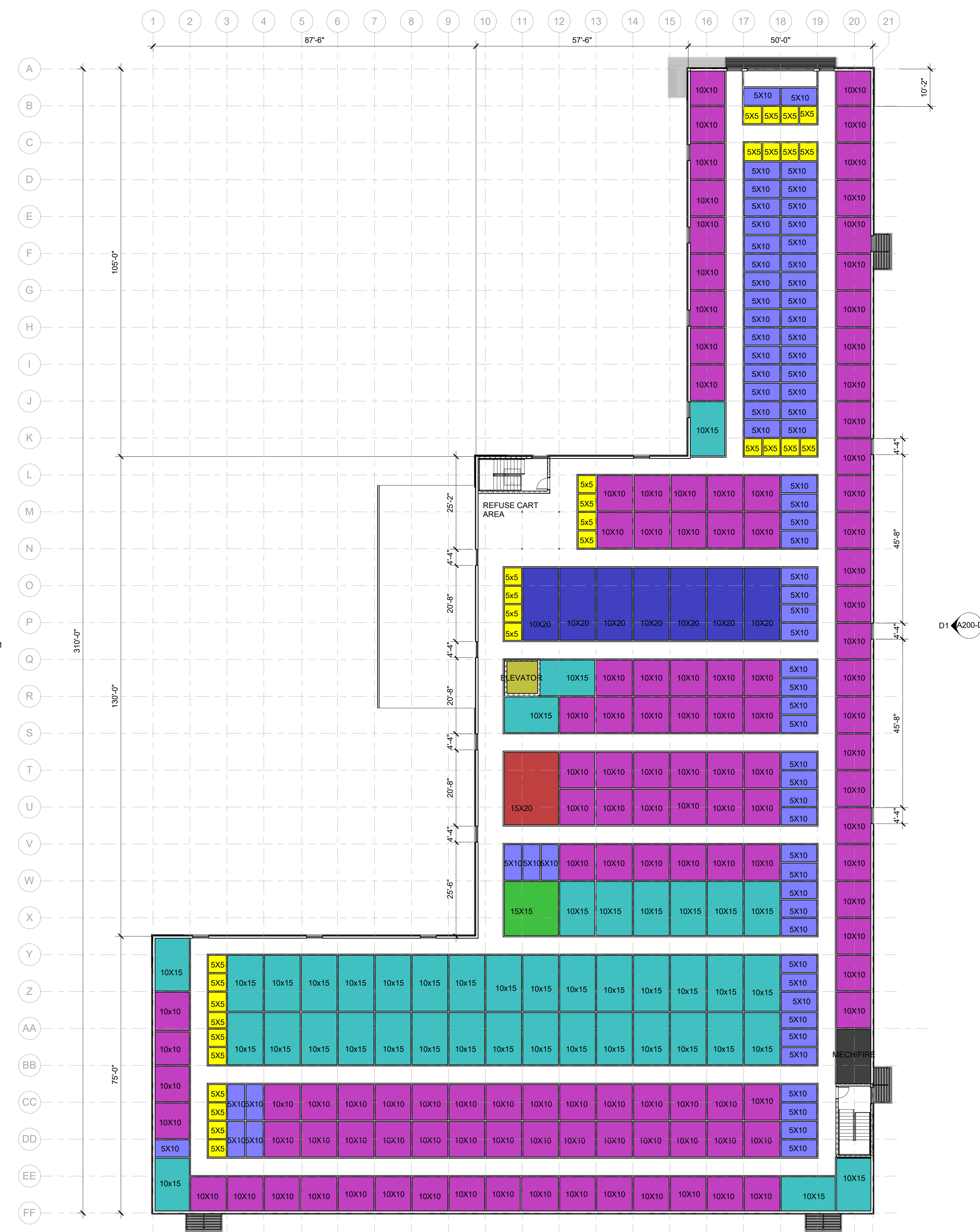

FLOORPLAN - LEVEL 2-3
1/16" = 1'-0" A1

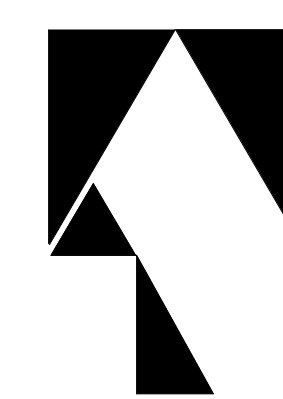

ADAMS
ARCHITECTS
700 Massachusetts St.
Suite 307
Lawrence, Kansas 66044
(785) 218-3880
www.adamsarchts.com

APPROVED BY:

Name: --- Date: ---

Name: --- Date: ---

Name: --- Date: ---

UNLESS A PROFESSIONAL SEAL WITH SIGNATURE AND DATE IS AFFIXED, THIS DOCUMENT IS PRELIMINARY AND IS NOT INTENDED FOR CONSTRUCTION.

REVISIONS

No.	Description	Date

Rel. Date: 1-13-23

ROOF PLAN LAYOUT
OPTION D

A150-D

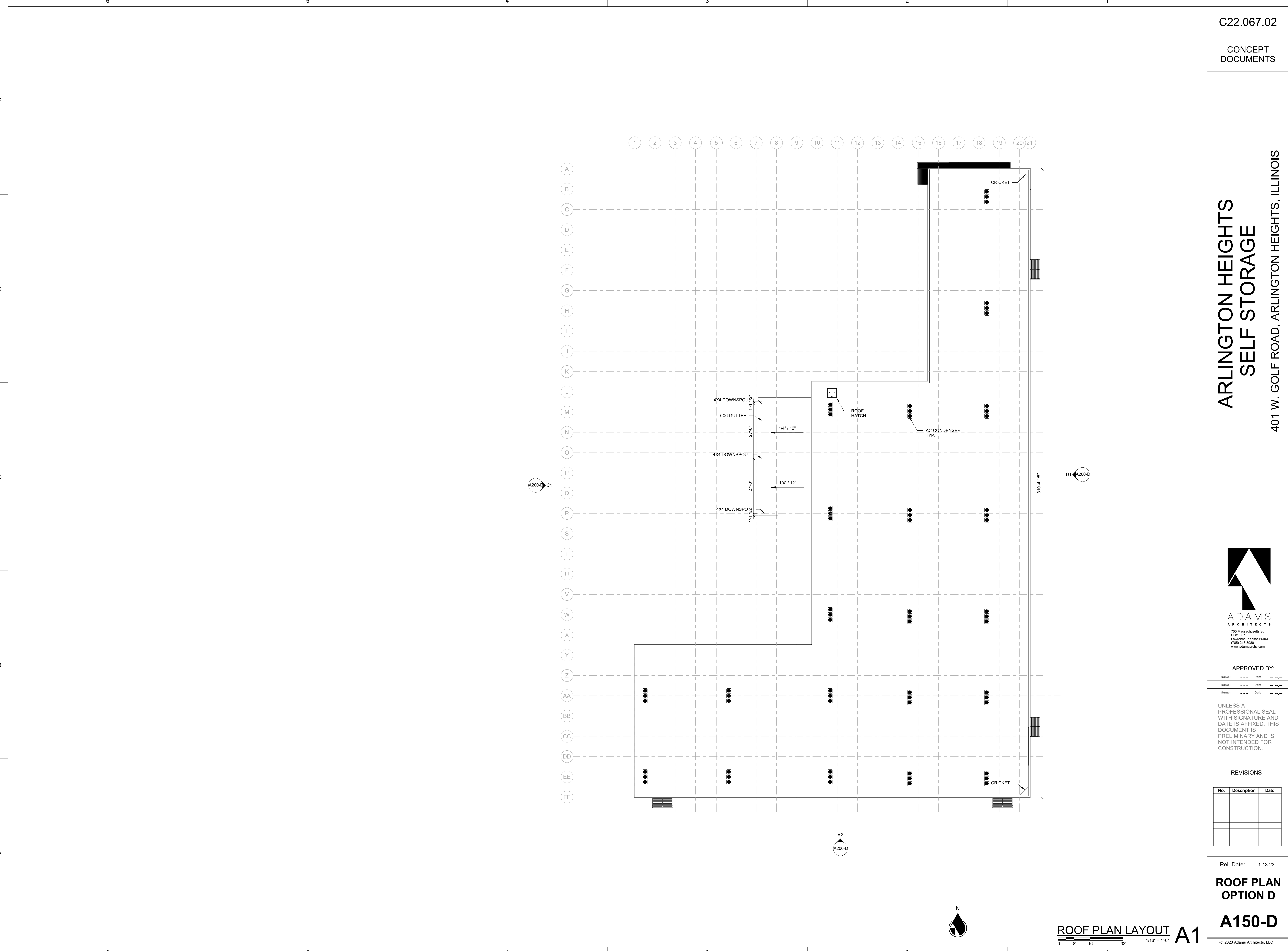

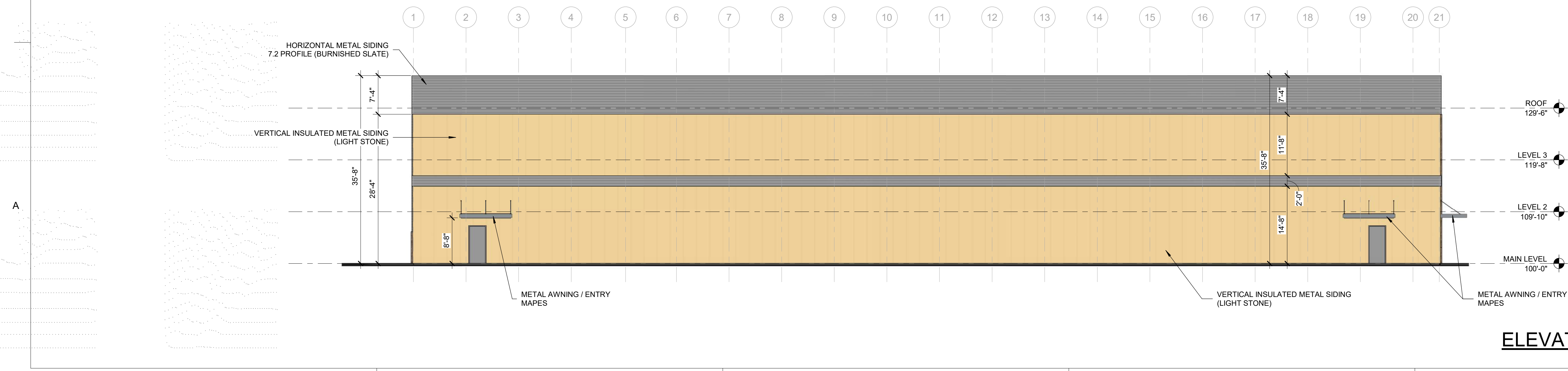
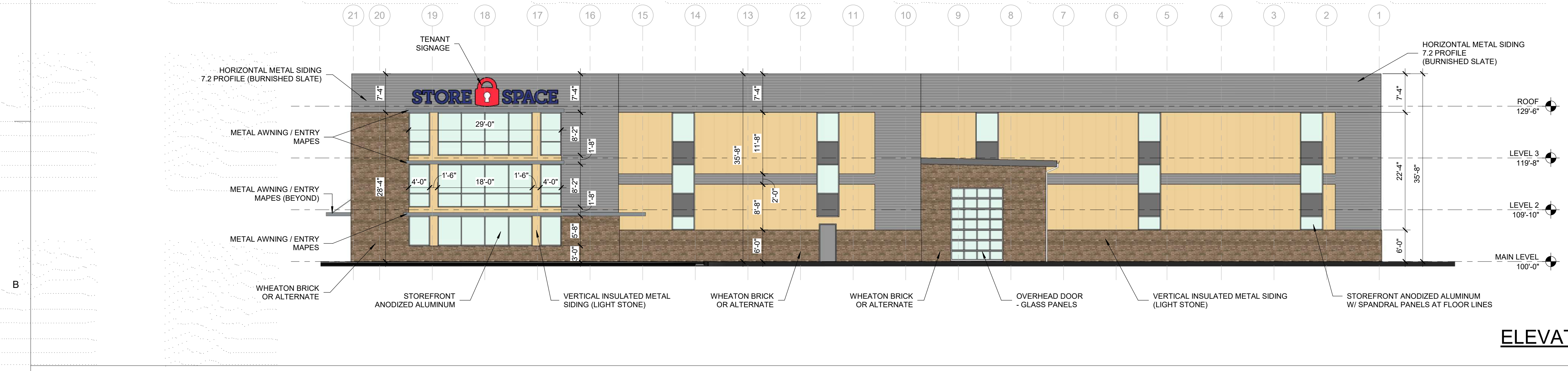
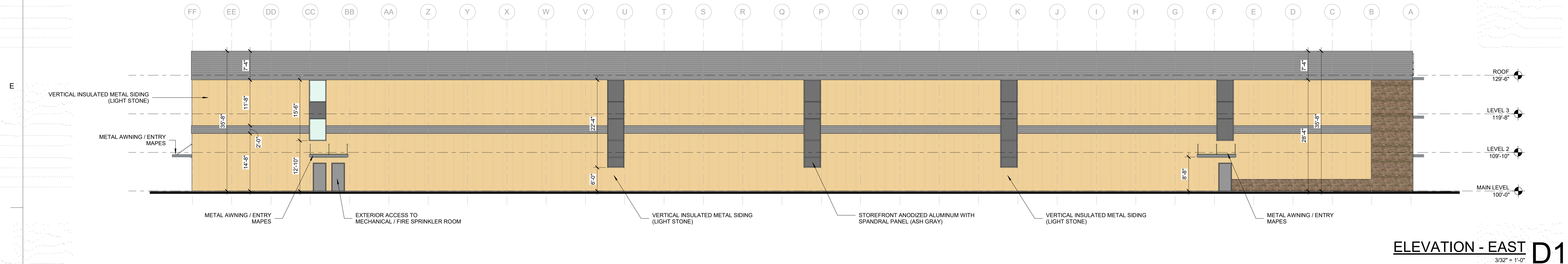

GENERAL NOTES:

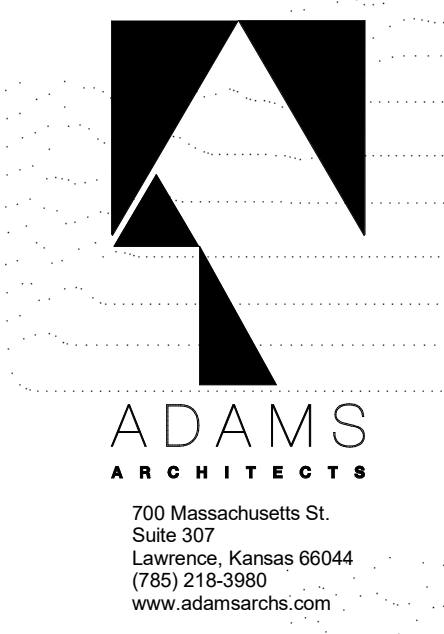

APPROVED BY:
Name: _____ Date: _____
Name: _____ Date: _____
Name: _____ Date: _____

UNLESS A PROFESSIONAL SEAL WITH SIGNATURE AND DATE IS AFFIXED, THIS DOCUMENT IS PRELIMINARY AND IS NOT INTENDED FOR CONSTRUCTION.

REVISIONS

No.	Description	Date

Rel. Date: 1-13-23

ELEVATIONS OPTION D

A200-D



RENDERINGS (CORNERS) C4
12" = 1'-0"



RENDERINGS (CORNERS) C1
12" = 1'-0"



RENDERINGS (CORNERS) A4
12" = 1'-0"



RENDERINGS (CORNERS) A1
12" = 1'-0"

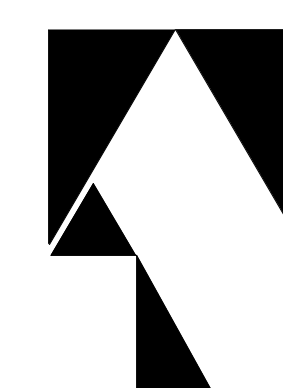

ADAMS ARCHITECTS
700 Massachusetts St.
Suite 307
Lawrence, Kansas 66044
(785) 218-3880
www.adamsarch.com

APPROVED BY:

Name: -- Date: --
Name: -- Date: --
Name: -- Date: --

UNLESS A PROFESSIONAL SEAL WITH SIGNATURE AND DATE IS AFFIXED, THIS DOCUMENT IS PRELIMINARY AND IS NOT INTENDED FOR CONSTRUCTION.

REVISIONS

No.	Description	Date

Rel. Date: 1-13-23

3D VIEWS
OPTION D

A800-D



AERIAL VIEW IMAGE C1
12" = 1'-0"



STREET VIEW IMAGE A1
12" = 1'-0"

C22.067.02

CONCEPT DOCUMENTS

ARLINGTON HEIGHTS
SELF STORAGE
401 W. GOLF ROAD, ARLINGTON HEIGHTS, ILLINOIS

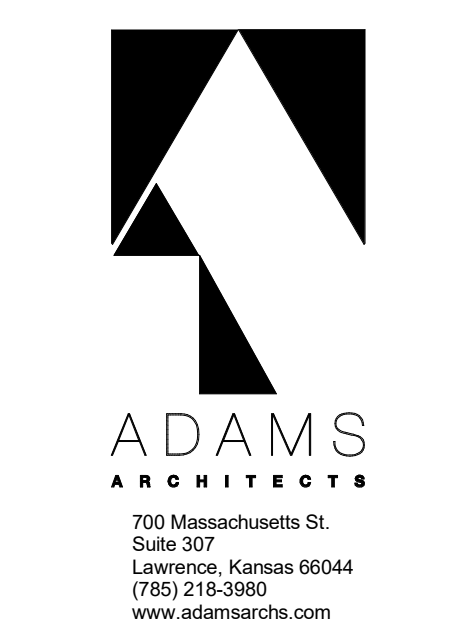

APPROVED BY:

Name: . . . Date: . . .
Name: . . . Date: . . .
Name: . . . Date: . . .

UNLESS A PROFESSIONAL SEAL WITH SIGNATURE AND DATE IS AFFIXED, THIS DOCUMENT IS PRELIMINARY AND IS NOT INTENDED FOR CONSTRUCTION.

REVISIONS

No.	Description	Date

Rel. Date: 1-13-23

3D VIEWS
OPTION D

A810-D

© 2023 Adams Architects, LLC